

## FRAME

- Kiln dried solid plantation wood and structural composites are glued, screwed and corner blocked.

## SUSPENSION

- No-Sag springs covered with fiber-tex

## SEAT CUSHIONS

- Cold cured moulded foam + fiber

## BACK CUSHIONS

- Cold cured moulded foam + fiber



3 SEAT DUO



1 SEAT



2.5 SEAT



3 SEAT



3 SEAT DUO

Legs options:



Wood Leg  
Straight



Wood Leg



Aluminum  
Polished Leg



Aluminum  
Black Leg

## Construction Features

- Frames are made from solid wood and laminated structural composites
- All corners are reinforced with corner blocks
- Separate seat and back cushions
- No-Sag spring seat frame
- Cold cured moulded foam + fiber
- Aluminum Polished, Aluminum Black and Wooden legs
- 2 seat cushions on 3 seater

## Options

- All IMG leathers, fabrics and wood colors can be selected
- 3 seat cushions on 3 seater

## Exclusive Warranty



10 years on molded foam cushions and steel frames  
 5 years on mechanisms  
 2 years on motor and battery-parts  
 2 years on leather and fabric covers

**10 YEAR WARRANTY** DESIGNED IN NORWAY

See warranty policy for more details.

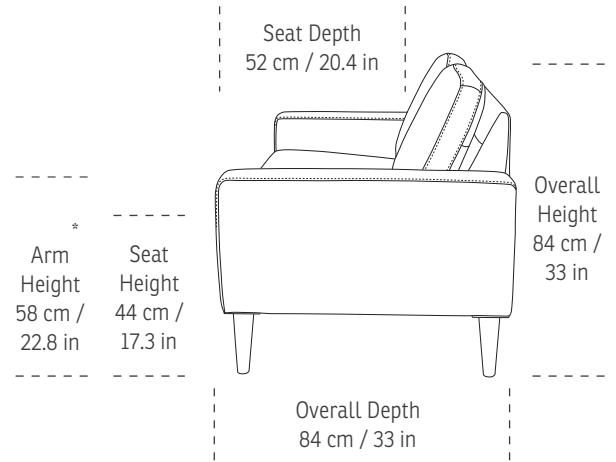

\*Note: Arm height for this frame is measured at the highest point of the arm.

\*The dimensions are approximate and may vary with +/- 2cm.

N190 - 1 SEAT

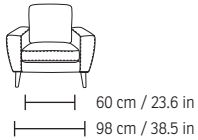

N190 - 2 SEAT

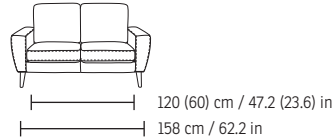

N190 - 2.5 SEAT

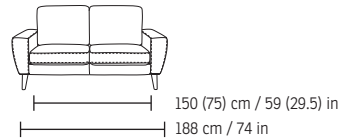

N190 - 1 SEAT 2 ARMS

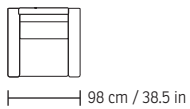

N190 - 2 SEAT 2 ARMS

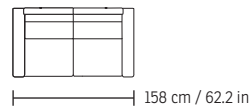

N190 - 2.5 SEAT 2 ARMS

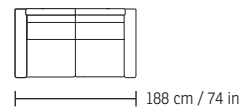

N190 - 3 SEAT DUO

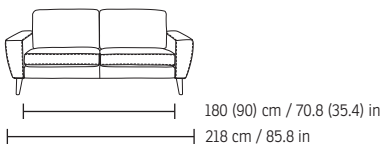

N190 - 3 SEAT

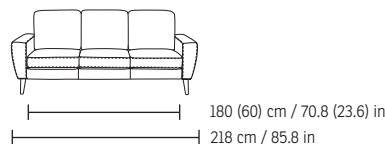

N190 - 3 SEAT DUO 2 ARMS

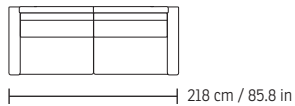

N190 - 3 SEAT 2 ARMS

